



ATREX 100 D

last update 28/09/2015

BEL1114

BEL LIGHTING

Atrex 100 D: code 790A.E2.04 max. 27W TC-TSE E27 or 75W A60 E27 - 230V~ - CE - IP65 -  -  - 

BEL LIGHTING sprl
Avenue Ernest Solvay 42
B-1480 Saintes (Tubize)
Belgium
Phone: +32(0)2 3552428
Fax: +32(0)2 3550396
e-mail: info@bel-lighting.com
www.bel-lighting.com

INSTALLATION INSTRUCTIONS - PART A

1. FIT THE FIXATION
2. MAKE THE ELECTRICAL CONNECTION
3. PLACE THE LUMINARY
4. SWITCH ON

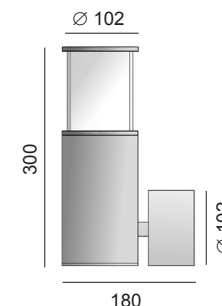

1 DIMENSIONS HOLES

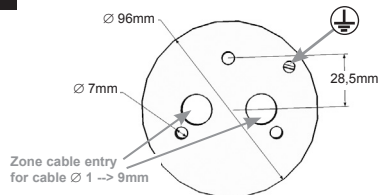

IMPORTANT : Gland for cable Ø 1 ----> 9mm

2 ELECTRICAL CONNECTION

NL - Voeg de voedingskabel in de beschermingskoker (A)
FR - Insérer le câble d'alimentation dans la gaine de protection(A).
EN - Insert the feeder in the protection sheath (A)
DE - Das Kabel in die Schutzhülle einfügen (A)
ΕΛ - Παρεμβάλετε τον τροφοδοτή στη θηκη προστασίας(A)

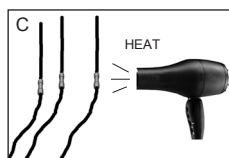
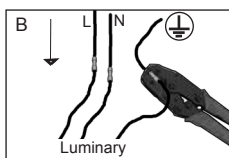
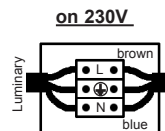

3

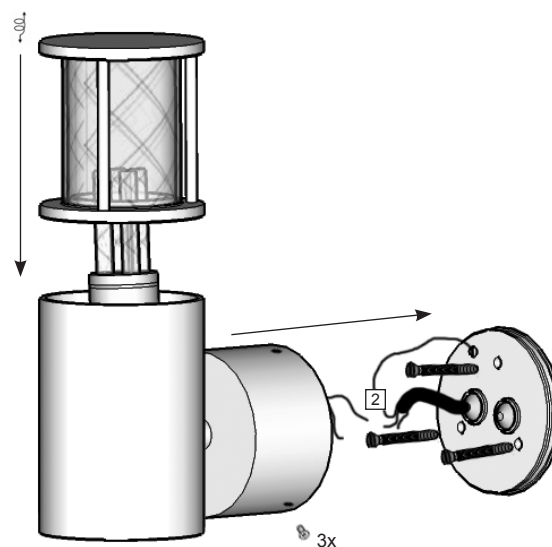

ACCESSORY SET (B)

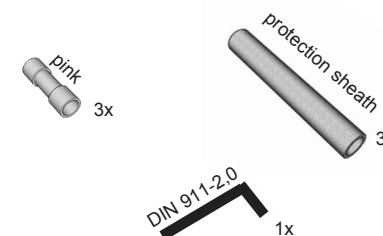

belpasta 1g

NL Voor een correcte installatie is het verplicht de schroeven te behandelen met belpasta.
FR Pour une bonne installation, vous devez enduire les parties à visser avec la graisse belpasta ci-jointe.
EN For a good installation, it is obliged to put the grease belpasta on the screwing part .
DE Sie müssen die Teile der Leuchte, die geschraubt werden mit dem beigefügten Fett belpasta bestreichen.
GR Για καλή εγκατάσταση, σας συνιστούμε να βαλετε στα σημεία προς βιδώμα λίγο γρasso belpasta, το οποίο βρίσκεται στην συσκευασία.

PART

A

Lees de algemene gebruiksvoorwaarden : PART B
Lire attentivement les conditions générales d'utilisation: PART B
Read attentively the general instructions: PART B
Lesen Sie die allgemeinen Gebrauchsanweisungen: PART B
Διαβάστε της γενικές οδηγίες : PART B

WAARSCHUWING
AVERTISSEMENT
WARNING
WARNUNG
ΠΡΟΣΟΧΗ