

ATREX & CUBIX & MANIX & ZEBRA Y



last update 03/11/2015

BEL1042



Atrex Y : code 769. _ _ . _ _

max.14W TC-TSE/E27 or max.70W QT32/E27 or max.60W QT14/G9 - 230V~ - CE - IP65 -  -  - 



Cubix Y : code 775. _ _ . _ _

max.20W TC-TSE/E27 or max.70W QT32/E27 or max.60W QT14/G9 - 230V~ - CE - IP65 -  -  - 

Manix Y : code 945. _ _ . _ _

max.20W TC-TSE/E27 or max.70W QT32/E27 or max.60W QT14/G9 - 230V~ - CE - IP65 -  -  - 

Zebra Y : code 762. _ _ . _ _

max.14W TC-TSE/E27 or max.70W QT32/E27 or max.60W QT14/G9 - 230V~ - CE - IP65 -  -  - 



BEL LIGHTING sprl
Avenue Ernest Solvay 42
B-1480 Saintes (Tubize)
Belgium
Phone: +32(0)2 3552428
Fax: +32(0)2 3550396
e-mail: info@bel-lighting.com
www.bel-lighting.com

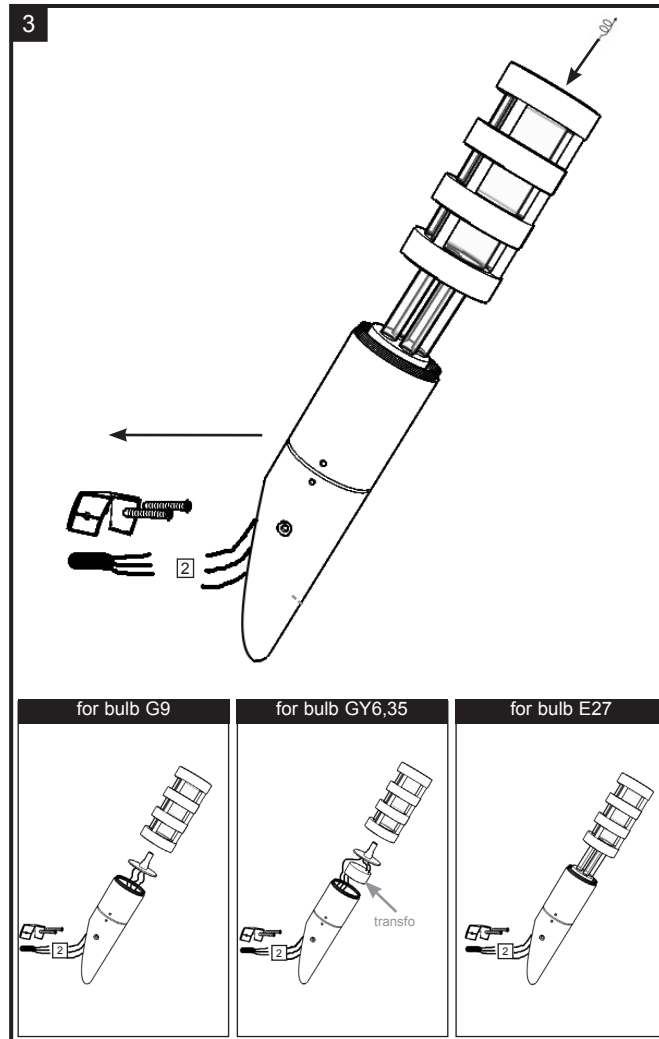
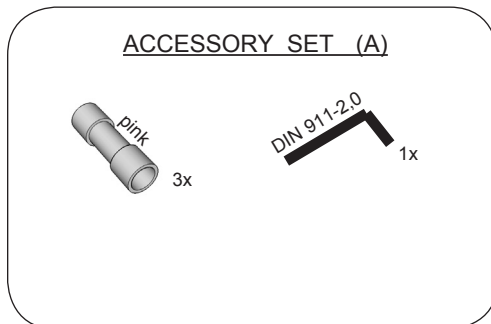
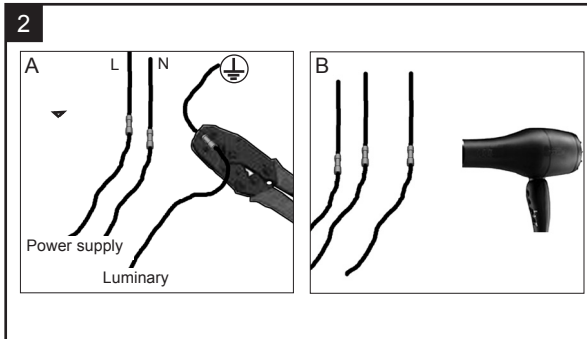
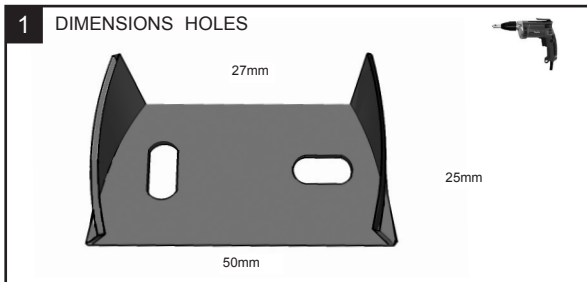

INSTALLATION INSTRUCTIONS - PART A

1. FIT THE WALL FIXATION ON THE WALL
2. MAKE THE ELECTRICAL CONNECTION
3. PLACE THE LUMINARY
4. SWITCH ON

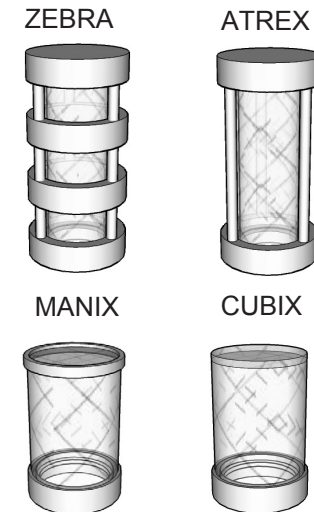

belpasta 1g

- NL Voor een correcte installatie is het verplicht de schroeven te behandelen met belpasta.
- FR Pour une bonne installation, vous devez enduire les parties à visser avec la graisse belpasta ci-jointe.
- EN For a good installation, it is obliged to put the grease belpasta on the screwing part.
- DE Sie müssen die Teile der Leuchte, die geschraubt werden mit dem beigefügten Fett belpasta bestreichen.
- GR Για καλή εγκατάσταση, σας συνιστούμε να βάζετε στα σημεία προς βιδώμα λίγο γρασο belpasta, το οποίο βρίσκεται στην συσκευασία.

PART

A

Lees de algemene gebruiksvoorwaarden : PART B
Lire attentivement les conditions générales d'utilisation : PART B
Read attentively the general instructions : PART B
Λεστέ τις γενικές οδηγίες : PART B

WAARSCHUWING
AVERTISSEMENT
WARNING
ΠΡΟΣΟΧΗ