

Koba TR - TB

last update 24/09/2015

BEL1138

Koba TR :	code 8047. _ 32 _ _ _	1x3,2W - 350mA - CE - IP65 - IK09 - 		
Koba TR :	code 8047. W03 _ _ _	1x3,0W - 230V~ - CE - IP65 - IK09 - 		
Koba TB :	code 8048. _ 32 _ _ _	1x3,2W - 230V~ - CE - IP65 - IK09 - 		

Koba TR



Koba TB

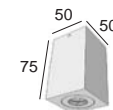

INSTALLATION INSTRUCTIONS - PART A

1. DIMENSION HOLES
2. MAKE THE ELECTRICAL CONNECTION
3. PLACE THE LUMINARY
4. SWITCH ON

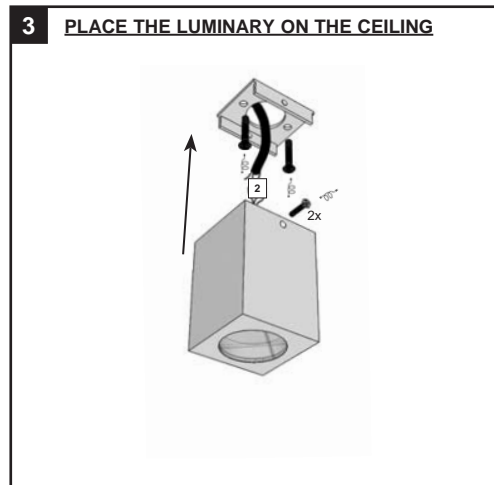
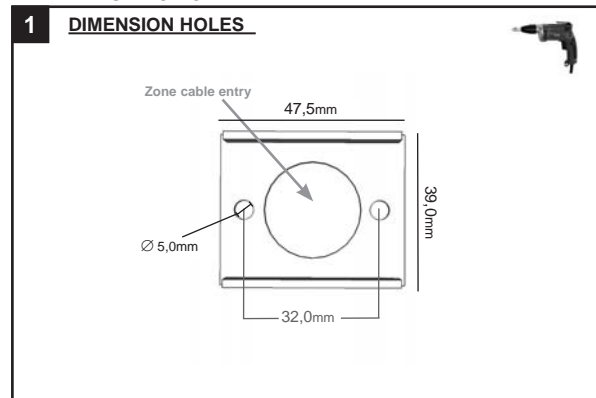

Installation : Led Power Supply

Red : +
Black : -

only use a Power supply delivery from BEL LIGHTING - SENICO

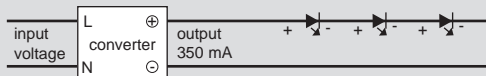

2 ELECTRICAL CONNECTION

- NL - Voeg de voedingskabel in de beschermingskoker (A)
 FR - Insérer le câble d'alimentation dans la gaine de protection(A).
 EN - Insert the feeder in the protection sheath (A)
 DE - Das Kabel in die Schutzhülle einfügen (A)
 EL - Παρεμβάλετε τον τροφοδοτή στη θήκη προστασίας(A)

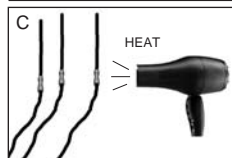
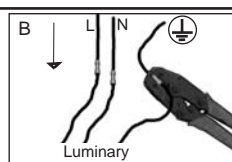
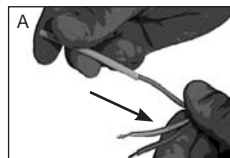
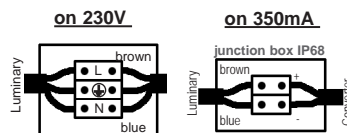

ACCESSORY SET (C)

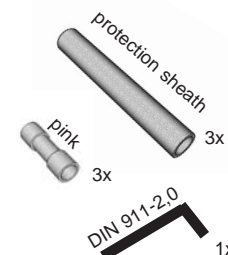

belpasta 1g

- NL Voor een correcte installatie is het verplicht de schroeven te behandelen met belpasta.
 FR Pour une bonne installation, vous devez enduire les parties à visser avec la graisse belpasta ci-jointe.
 EN For a good installation, it is obliged to put the grease belpasta on the screwing part .
 DE Sie müssen die Teile der Leuchte, die geschraubt werden mit dem beigefügten Fett belpasta bestreichen.
 GR Για καλή εγκατάσταση, σας συνιστούμε να βάλετε στα σημεία προς βιδώμα λίγο γράσο belpasta, το οποίο βρίσκεται στην συσκευασία.



BEL LIGHTING sprl
 Avenue Ernest Solvay 42
 B-1480 Saintes (Tubize)
 Belgium
 Phone: +32(0)2 3552428
 Fax: +32(0)2 3550396
 e-mail: info@bel-lighting.com
 www.bel-lighting.com

PART A

Lees de algemene gebruiksvoorwaarden : PART B
 Lire attentivement les conditions générales d'utilisation: PART B
 Read attentively the general instructions: PART B
 Lesen Sie die allgemeinen Gebrauchsanweisungen: PART B
 Διαβάστε της γενικές οδηγίες : PART B

WAARSCHUWING
 AVERTISSEMENT
 WARNING
 ΠΡΟΣΟΧΗ