



Squadra G

last update 24/09/2015

BEL1130

Squadra G: code 8040.1G9.___

2 x QT14/G9 max. 40W - 230V~ - CE - IP65 -   - 

Squadra G: code 8040.W80.___

Power Led 2 x 6W - 230V~ - CE - IP65 -   - 

BEL LIGHTING

BEL LIGHTING sprl
Avenue Ernest Solvay 42
B-1480 Saintes (Tubize)
Belgium
Phone: +32(0)2 3552428
Fax: +32(0)2 3550396
e-mail: info@bel-lighting.com
www.bel-lighting.com

INSTALLATION INSTRUCTIONS - PART A

1. FIT THE WALL FIXATION ON THE WALL
2. MAKE THE ELECTRICAL CONNECTION
3. PLACE THE LUMINARY
4. SWITCH ON

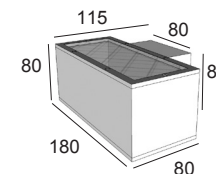

PART

A

1 DIMENSIONS HOLES

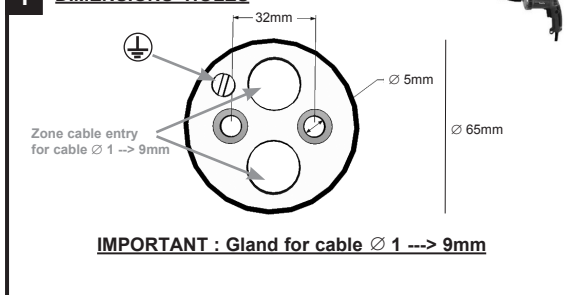

2 ELECTRICAL CONNECTION

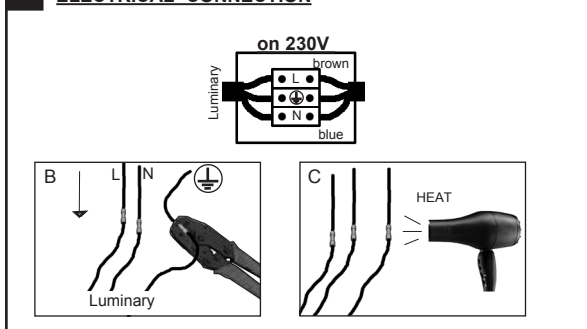

3 PLACE THE LUMINARY

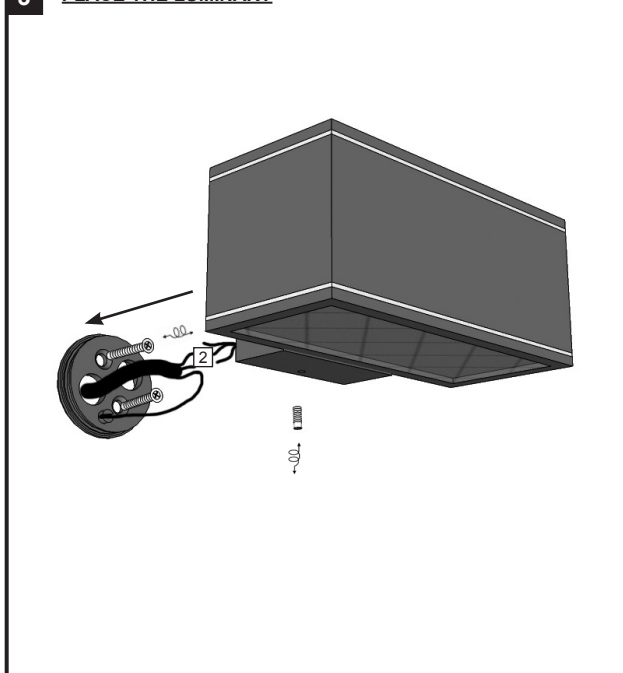

ACCESSORY SET (B)

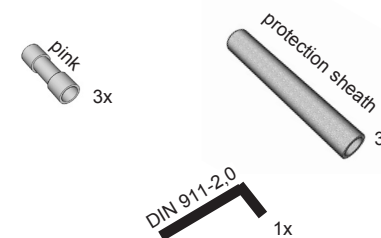

belpasta 1g

- NL Voor een correcte installatie is het verplicht de schroeven te behandelen met belpasta.
- FR Pour une bonne installation, vous devez enduire les parties à visser avec la graisse belpasta ci-jointe.
- EN For a good installation, it is obliged to put the grease belpasta on the screwing part.
- DE Sie müssen die Teile der Leuchte, die geschraubt werden mit dem beigefügten Fett belpasta bestreichen.
- GR Για καλή εγκατάσταση, σας συνιστούμε να βάλετε στα σημεία προς βίδωμα λίγο γράσο belpasta, το οποίο βρίσκεται στην συσκευασία.

Lees de algemene gebruiksvoorwaarden : PART B
Lire attentivement les conditions générales d'utilisation: PART B
Read attentively the general instructions: PART B
Λεσεν Σιε die algemeinen Gebrauchsanweisungen: PART B
Διαβάστε της γενικές οδηγίες : PART B

WAARSCHUWING
AVERTISSEMENT
WARNING
WARNUNG
ΠΡΟΣΟΧΗ