



ONYX & ATLANTIC & NOBUS & CUBIX & MANIX ZEBRA & ATREX G

last update 28/09/2015

BEL1109

Onyx G :	code 703. 2G. __	max. 60W QT14 G9 - 230V~ + max. 50W QPAR16 GU10 - 230V~ - CE - IP65 -  -  - 
Atlantic G :	code 173. 2G. __	max. 60W QT14 G9 - 230V~ + max. 50W QPAR16 GU10 - 230V~ - CE - IP65 -  -  - 
Nobus G :	code 171. 2G. __	max. 60W QT14 G9 - 230V~ + max. 50W QPAR16 GU10 - 230V~ - CE - IP65 -  -  - 
Cubix G :	code 932. 2G. 04	max. 60W QT14 G9 - 230V~ + max. 50W QPAR16 GU10 - 230V~ - CE - IP65 -  -  - 
Manix G :	code 944. 2G. 04	max. 60W QT14 G9 - 230V~ + max. 50W QPAR16 GU10 - 230V~ - CE - IP65 -  -  - 
Zebra G :	code 798. 2G .04	max. 60W QT14 G9 - 230V~ + max. 50W QPAR16 GU10 - 230V~ - CE - IP65 -  -  - 
Atrex G :	code 770. 2G. 04	max. 60W QT14 G9 - 230V~ + max. 50W QPAR16 GU10 - 230V~ - CE - IP65 -  -  - 

INSTALLATION INSTRUCTIONS - PART A

1. FIT THE WALL FIXATION ON THE WALL
2. MAKE THE ELECTRICAL CONNECTION
3. PLACE THE LUMINARY
4. SWITCH ON

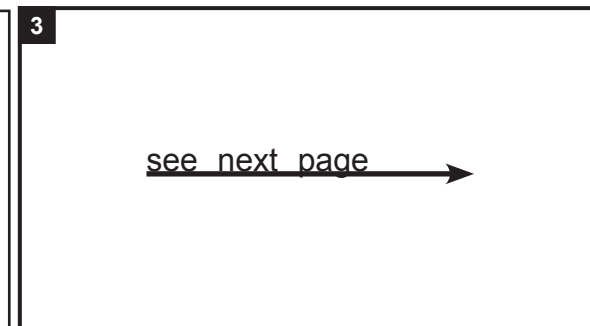
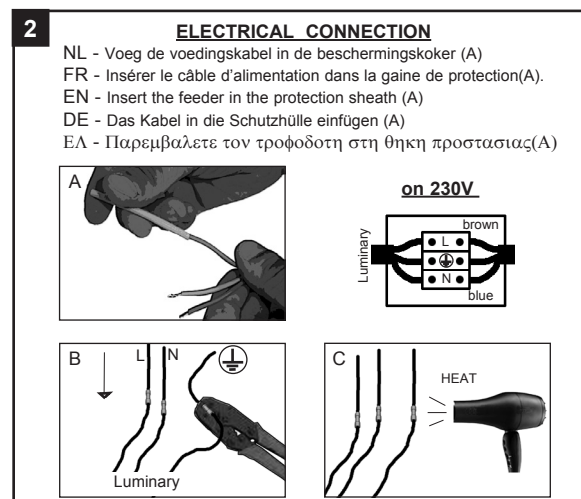
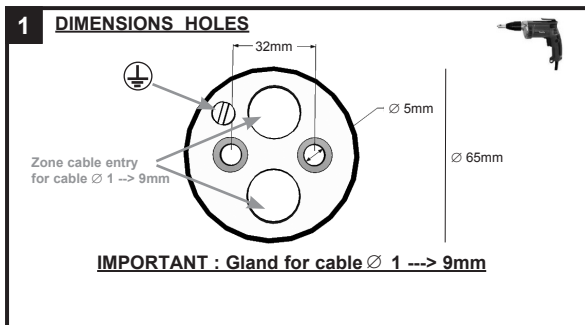

BEL LIGHTING

BEL LIGHTING sprl
 Avenue Ernest Solvay 42
 B-1480 Saintes (Tubize)
 Belgium
 Phone: +32(0)2 3552428
 Fax: +32(0)2 3550396
 e-mail: info@bel-lighting.com
 www.bel-lighting.com

PART

A

Lees de algemene gebruiksvoorwaarden : PART B
 Lire attentivement les conditions générales d'utilisation: PART B
 Read attentively the general instructions: PART B
 Lesen Sie die allgemeinen Gebrauchsanweisungen: PART B
 Διαβάστε της γενικές οδηγίες : PART B

WAARSCHUWING
 AVERTISSEMENT
 WARNING
 WARNUNG
 ΠΡΟΣΟΧΗ

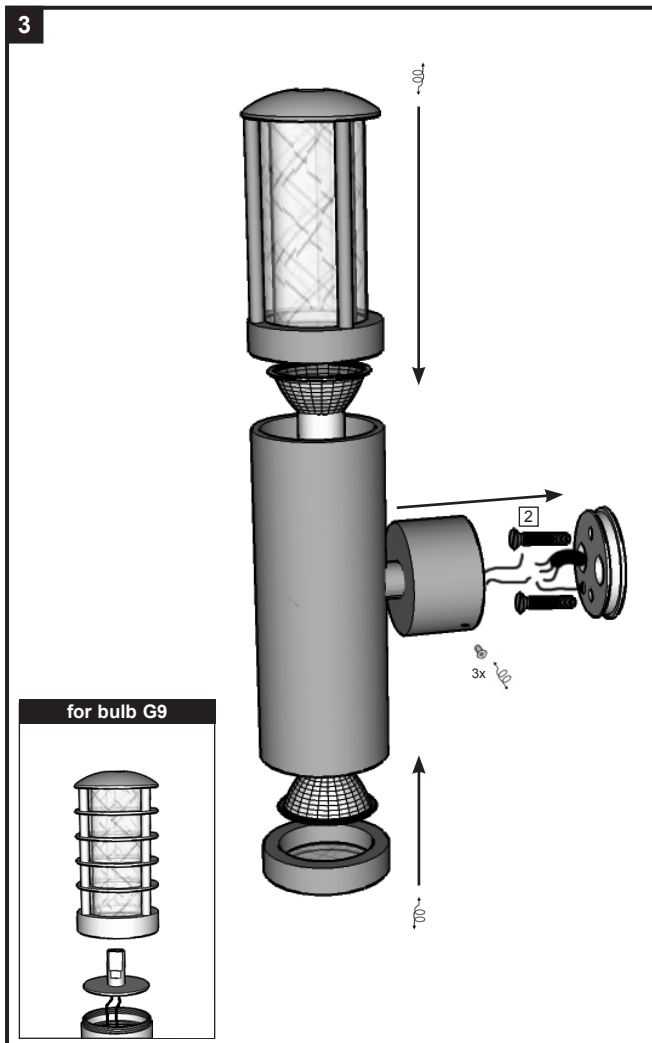

ATLANTIC

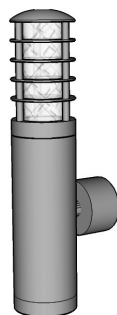

NOBUS

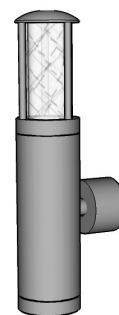

ONYX

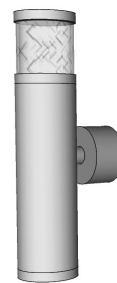

CUBIX

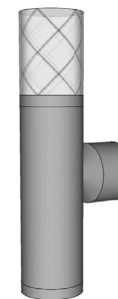

MANIX

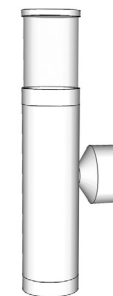

ATREX

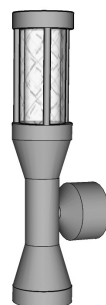

ZEBRA

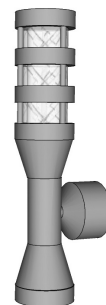

ACCESSORY SET (B)

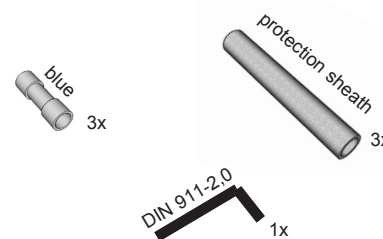

belpasta 1g

- NL Voor een correcte installatie is het verplicht de schroeven te behandelen met belpasta.
- FR Pour une bonne installation, vous devez enduire les parties à visser avec la graisse belpasta ci-jointe.
- EN For a good installation, it is obliged to put the grease belpasta on the screwing part.
- DE Sie müssen die Teile der Leuchte, die geschraubt werden mit dem beigefügten Fett belpasta bestreichen.
- GR Για καλή εγκατάσταση, σας συνιστούμε να βάζετε στα σημεία προς βίδωμα λίγο γράσο belpasta, το οποίο βρίσκεται στην συσκευασία.