



Keyko

last update 24/09/2015

BEL1139

Keyko : code 8056.1_37_ __ 6,5W - 230V - CE - IP65 - IK09 -  -  0,5 - 

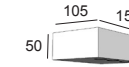



BEL LIGHTING

BEL LIGHTING sprl
Avenue Ernest Solvay 42
B-1480 Saintes (Tubize)
Belgium
Phone: +32(0)2 3552428
Fax: +32(0)2 3550396
e-mail: info@bel-lighting.com
www.bel-lighting.com

INSTALLATION INSTRUCTIONS - PART A

1. DIMENSION HOLES
2. MAKE THE ELECTRICAL CONNECTION
3. PLACE THE LUMINARY
4. SWITCH ON

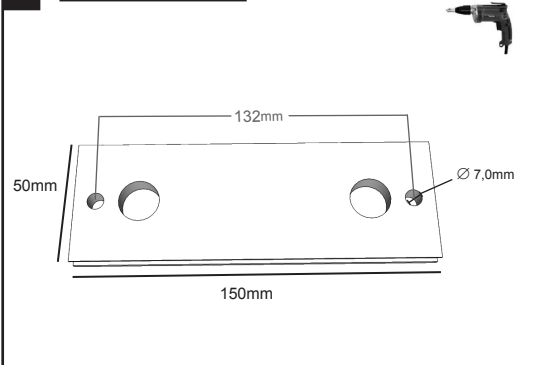
1 DIMENSION HOLES



2 ELECTRICAL CONNECTION

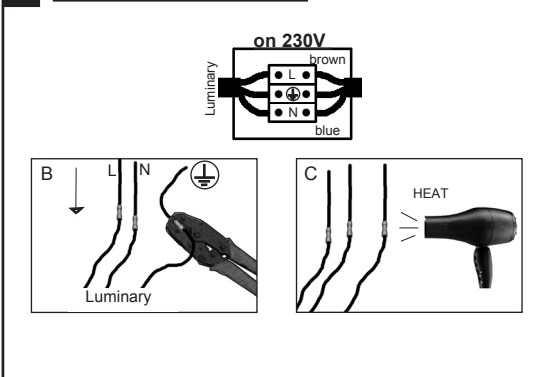

3 PLACE THE LUMINARY ON THE WALL

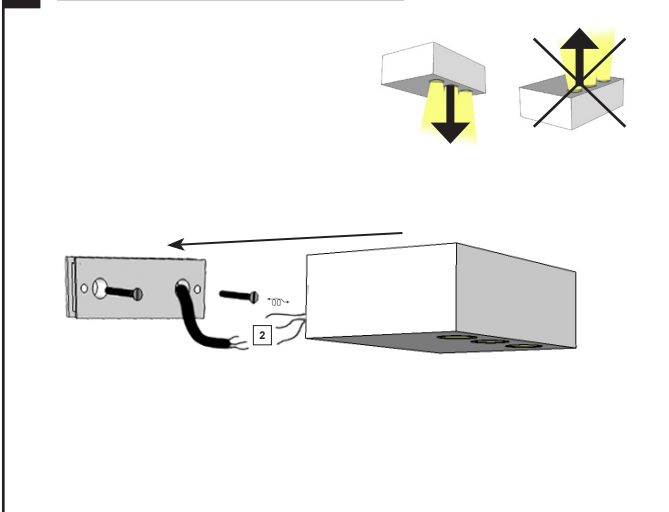

ACCESSORY SET (A)

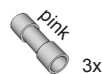

PART

A

Lees de algemene gebruiksvoorwaarden : PART B
Lire attentivement les conditions générales d'utilisation: PART B
Read attentively the general instructions: PART B
Lesen Sie die allgemeinen Gebrauchsanweisungen: PART B
Διαβάστε της γενικές οδηγίες : PART B

WAARSCHUWING
AVERTISSEMENT
WARNING
WARNUNG
ΠΡΟΣΟΧΗ