













ATREX & CUBIX & MANIX & ZEBRA D

last update 03/11/2015

BEL1040



BEL LIGHTING sprl
Avenue Ernest Solvay 42
B-1480 Saintes (Tubize)
Belgium
Phone: +32(0)2 3552428
Fax: +32(0)2 3550396
e-mail: info@bel-lighting.com
www.bel-lighting.com

Atrex D :	code 768. _ _ . _ _	max.14W TC-TSE/E27 or max.70W QT32/E27 or max.60W QT14/G9 - 230V~ - CE - IP65 -  -  - 
Cubix D :	code 774. _ _ . _ _	max.20W TC-TSE/E27 or max.70W QT32/E27 or max.60W QT14/G9 - 230V~ - CE - IP65 -  -  - 
Manix D :	code 942. _ _ . _ _	max.20W TC-TSE/E27 or max.70W QT32/E27 or max.60W QT14/G9 - 230V~ - CE - IP65 -  -  - 
Zebra D :	code 761. _ _ . _ _	max.14W TC-TSE/E27 or max.70W QT32/E27 or max.60W QT14/G9 - 230V~ - CE - IP65 -  -  - 

PART

A

INSTALLATION INSTRUCTIONS - PART A

1. FIT THE WALL FIXATION ON THE WALL
2. MAKE THE ELECTRICAL CONNECTION
3. PLACE THE LUMINARY
4. SWITCH ON

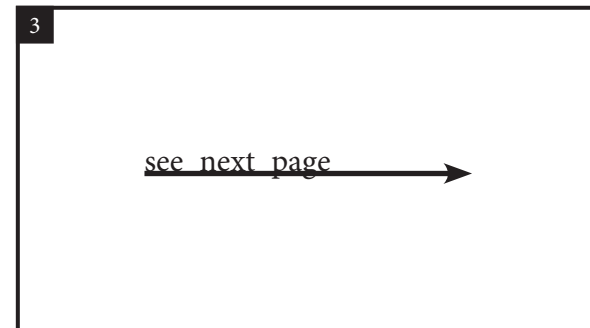
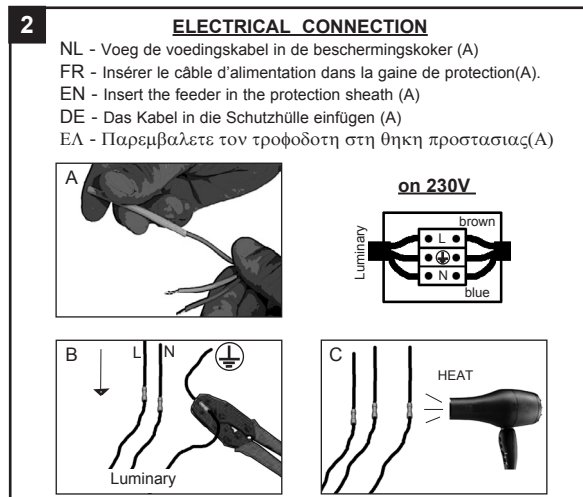
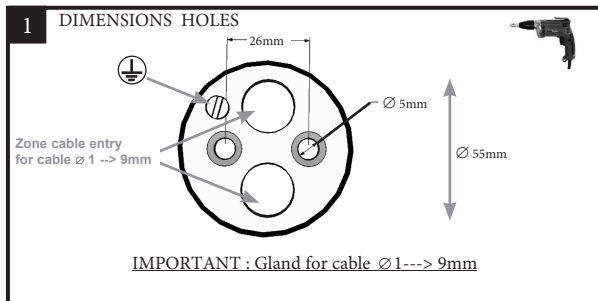

Lees de algemene gebruiksvoorwaarden : PART B
Lire attentivement les conditions generales d'utilisation: PART B
Read attentively the general instructions: PART B
Lesen Sie die allgemeinen Gebrauchsanweisungen: PART B
Αναβάστε της γενικές οδηγίες : PART B

WAARSCHUWING
AVERTISSEMENT
WARNING
WARNUNG
ΠΡΟΣΟΧΗ

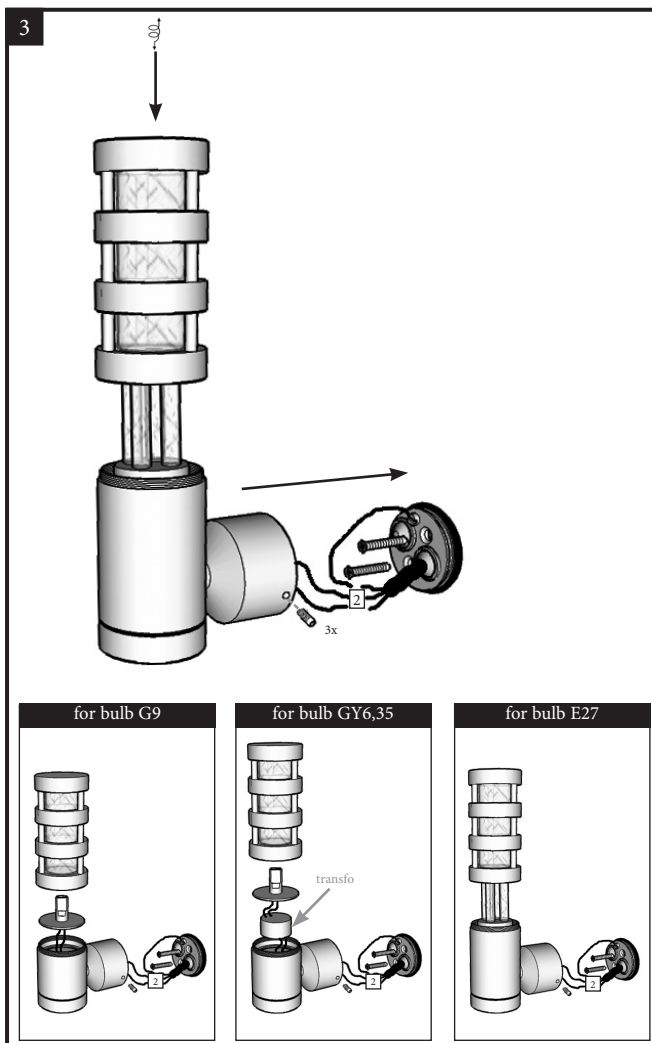

ZEBRA

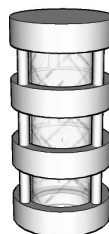

ATREX

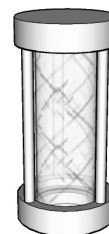

MANIX



CUBIX



ACCESSORY SET (B)

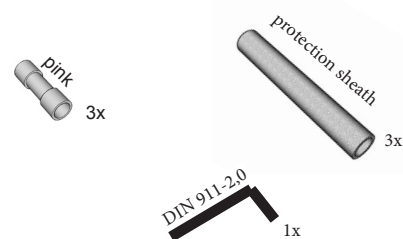

belpasta 1g

NL Voor een correcte installatie is het verplicht de schroeven te behandelen met belpasta.

FR Pour une bonne installation, vous devez enduire les parties à visser avec la graisse belpasta ci-jointe.

EN For a good installation, it is obliged to put the grease belpasta on the screwing part.

DE Sie müssen die Teile der Leuchte, die geschraubt werden mit dem beigefügten Fett belpasta bestreichen.

GR Για καλή εγκατάσταση, σας συνιστούμε να βάλετε στα σημεία προς βίδωμα λίγο γρασο belpasta, το οποίο βρίσκεται στην συσκευασία.