



















# Omega - Taf

last update 24/09/2015

BEL1049

**BEL LIGHTING**

BEL LIGHTING srl  
Avenue Ernest Solvay 42  
B-1480 Saintes (Tubize)  
Belgium  
Phone: +32(0)2 3552428  
Fax: +32(0)2 3550396  
e-mail: info@bel-lighting.com  
www.bel-lighting.com

<b>Omega 1:</b>	code 910SA.G9. __	max.60W H-PIN/G9 - CE - IP65 (exterior) or IP40 (interior) -  -  - 0,5mm - 
<b>Omega 1:</b>	code 910SA.W6. __	LED 6W - 230V~ - CE - IP65 (exterior) or IP40 (interior) -  -  - 0,5mm - 
<b>Omega 2:</b>	code 913SA.G9. __	max.60W H-PIN/G9 - 230V~ - CE - IP65 (exterior) or IP40 (interior) -  -  - 0,5mm - 
<b>Taf 1:</b>	code 914SA.G9. __	max.60W H-PIN/G9 - CE - IP65 (exterior) or IP40 (interior) -  -  - 0,5mm - 
<b>Taf 1:</b>	code 914SA.W6. __	LED 6W - 230V~ - CE - IP65 (exterior) or IP40 (interior) -  -  - 0,5mm - 
<b>Taf 2:</b>	code 917SA.G9. __	max.60W H-PIN/G9 - 230V~ - CE - IP65 (exterior) or IP40 (interior) -  -  - 0,5mm - 

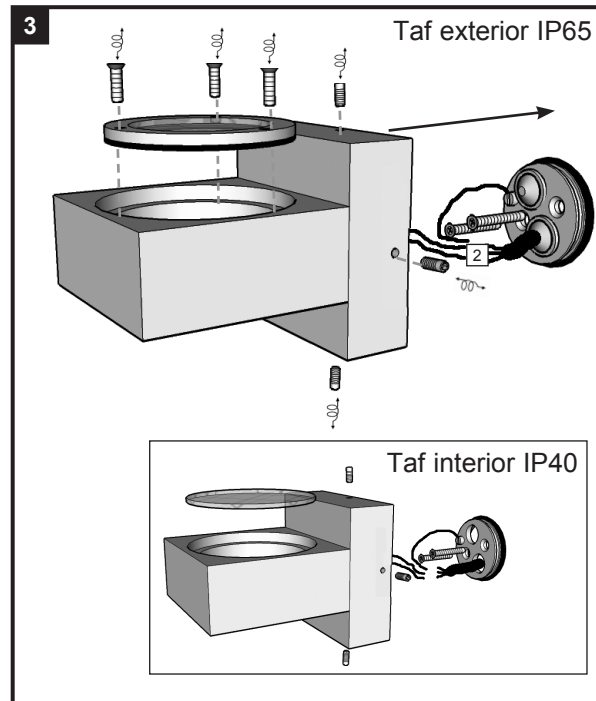
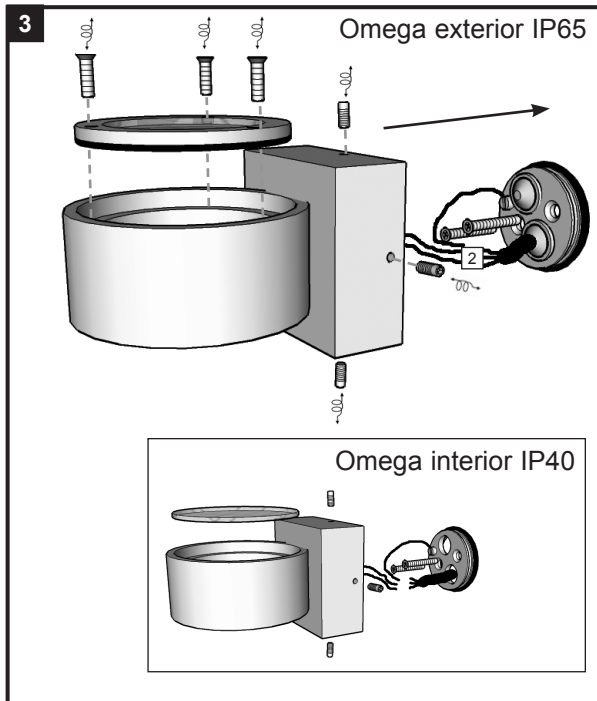
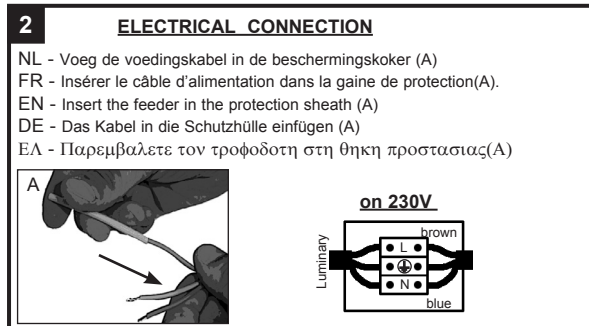
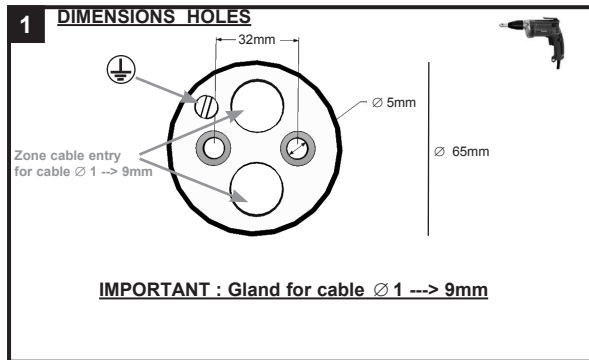

**INSTALLATION INSTRUCTIONS - PART A**

1. FIT THE WALL FIXATION ON THE WALL
2. MAKE THE ELECTRICAL CONNECTION
3. PLACE THE LUMINARY
4. SWITCH ON

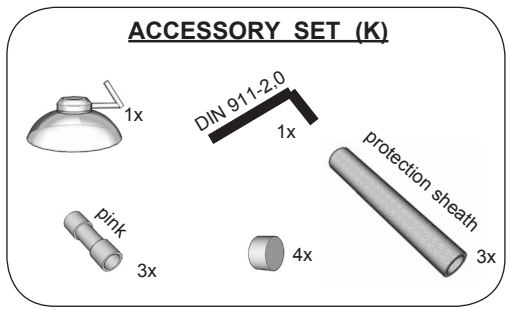

**belpasta 1g**  
(for exterior lighting)

NL Voor een correcte installatie is het verplicht de schroeven te behandelen met belpasta.  
FR Pour une bonne installation, vous devez enduire les parties à visser avec la graisse belpasta ci-jointe.  
EN For a good installation, it is obliged to put the grease belpasta on the screwing part.  
DE Sie müssen die Teile der Leuchte, die geschraubt werden mit dem beigegeführten Fett belpasta bestreichen.  
GR Για καλή εγκατάσταση, σας συνιστούμε να βάλετε στα σημεία προς βίδωμα λίγο γρασο belpasta, το οποίο βρίσκεται στην συσκευασία.

**PART**

**A**

Lees de algemene gebruiksvoorwaarden : PART B  
Lire attentivement les conditions générales d'utilisation: PART B  
Read attentively the general instructions: PART B  
Lesen Sie die allgemeinen Gebrauchsanweisungen: PART B  
Αναβάστε της γενικες οδηγίες : PART B

**WAARSCHUWING**  
**AVERTISSEMENT**  
**WARNING**  
**ΠΡΟΣΟΧΗ**

Wijzigingen in ontwerp, technische specificaties en handleiding voorbehouden.  
Sous réserve de modifications au niveau de la conception, des spécifications techniques et de la notice.

Alterations in design, technical specification and manuals reserved.  
Änderungen von Entwurf, technischen Daten und Bedienungsanleitungen bleiben vorbehalten.



















# Omega IN - Taf IN

last update 24/09/2015

BEL1049

**BEL LIGHTING**

BEL LIGHTING sprl  
Avenue Ernest Solvay 42  
B-1480 Saintes (Tubize)  
Belgium  
Phone: +32(0)2 3552428  
Fax: +32(0)2 3550396  
e-mail: info@bel-lighting.com  
www.bel-lighting.com

<b>Omega 1 IN:</b> code 911SA.G9. __	max.60W H-PIN/G9 - CE - IP44 (exterior) or IP40 (interior) -  -  - 0,5mm - 
<b>Omega 1 IN:</b> code 911SA.W6. __	LED 6W - 230V~ - CE - IP44 (exterior) or IP40 (interior) -  -  - 0,5mm - 
<b>Omega 2 IN:</b> code 912SA.G9. __	max.60W H-PIN/G9 - 230V~ - CE - IP44 (exterior) or IP40 (interior) -  -  - 0,5mm - 
<b>Taf 1 IN:</b> code 915SA.G9. __	max.60W H-PIN/G9 - CE - IP44 (exterior) or IP40 (interior) -  -  - 0,5mm - 
<b>Taf 1 IN:</b> code 915SA.W6. __	LED 6W - 230V~ - CE - IP44 (exterior) or IP40 (interior) -  -  - 0,5mm - 
<b>Taf 2 IN:</b> code 916SA.G9. __	max.60W H-PIN/G9 - 230V~ - CE - IP44 (exterior) or IP40 (interior) -  -  - 0,5mm - 

## INSTALLATION INSTRUCTIONS - PART A

1. FIT THE PVC HOUSE BOX IN THE WALL
2. MAKE THE ELECTRICAL CONNECTION
3. PLACE THE LUMINARY
4. SWITCH ON

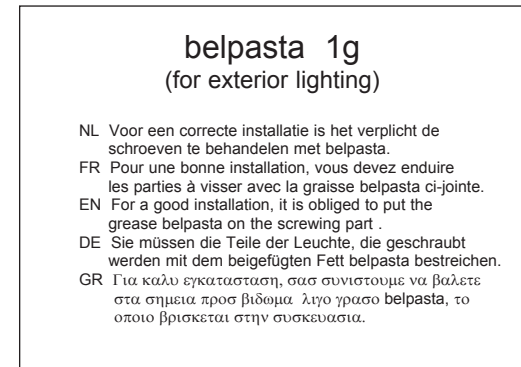
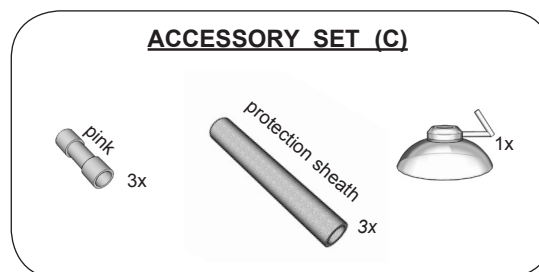
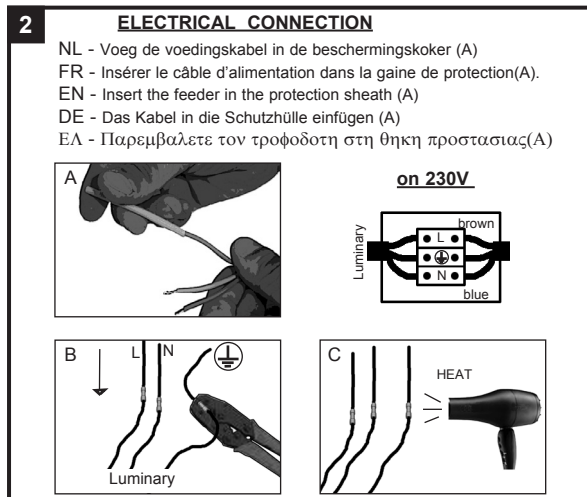
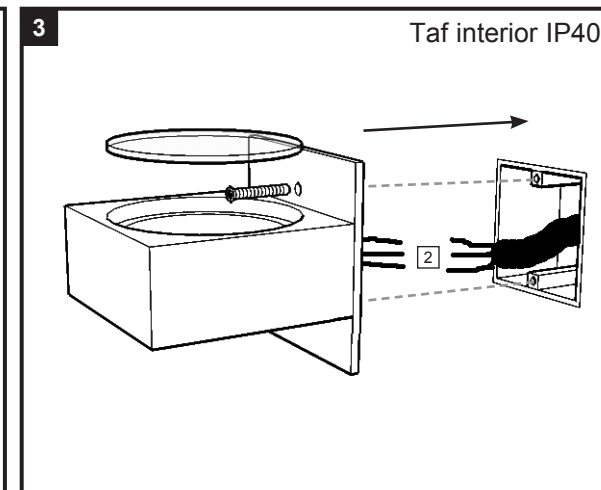
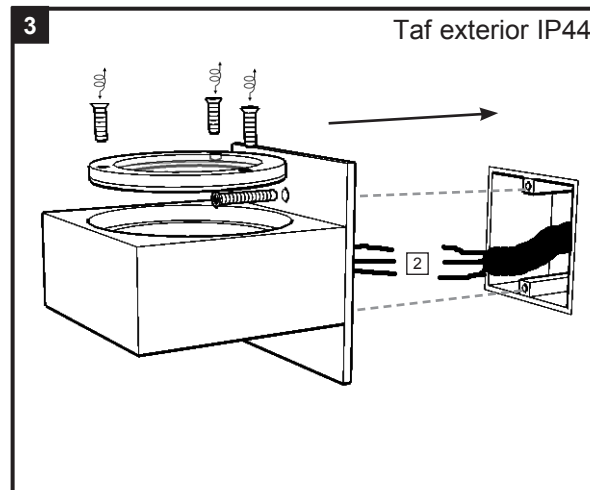
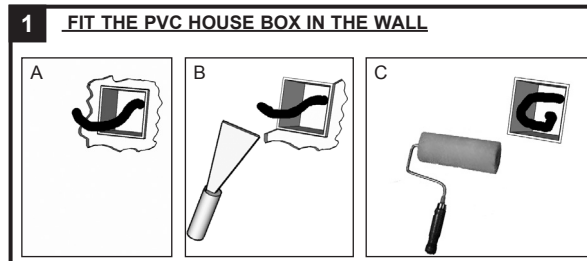

# PART A

Lees de algemene gebruiksvaarden : PART B  
Lire attentivement les conditions générales d'utilisation: PART B  
Read attentively the general instructions: PART B  
Lesen Sie die allgemeinen Gebrauchsanweisungen: PART B  
Αναβάστε της γενικές οδηγίες : PART B

**WAARSCHUWING**  
**AVERTISSEMENT**  
**WARNING**  
**WARNING**  
ΠΡΟΣΟΧΗ