

ONYX & ATLANTIC BIS

last update 28/09/2015

BEL1108

Onyx Bis : code 704. ___ . ___

max. 2x20W TC-TSE E27 or 2x70W QT32 E27 or 2x40W QT14 G9 - 230V~ - CE - IP65 -  -  - 

Atlantic Bis: code 737. ___ . ___

max. 2x14W TC-TSE E27 or 2x70W QT32 E27 or 2x60W QT14 G9 - 230V~ - CE - IP65 -  -  - 



BEL LIGHTING sprl
Avenue Ernest Solvay 42
B-1480 Saintes (Tubize)
Belgium
Phone: +32(0)2 3552428
Fax: +32(0)2 3550396
e-mail: info@bel-lighting.com
www.bel-lighting.com

INSTALLATION INSTRUCTIONS - PART A

1. FIT THE WALL FIXATION ON THE WALL
2. MAKE THE ELECTRICAL CONNECTION
3. PLACE THE LUMINARY
4. SWITCH ON

1 DIMENSIONS HOLES

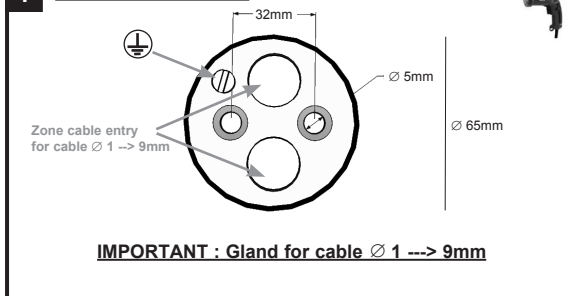

2 ELECTRICAL CONNECTION

NL - Voeg de voedingskabel in de beschermingskoker (A)
FR - Insérer le câble d'alimentation dans la gaine de protection(A).
EN - Insert the feeder in the protection sheath (A)
DE - Das Kabel in die Schutzhülle einfügen (A)
ΕΛ - Παρεμβάλετε τον τροφοδοτή στη θηκη προστασίας(A)

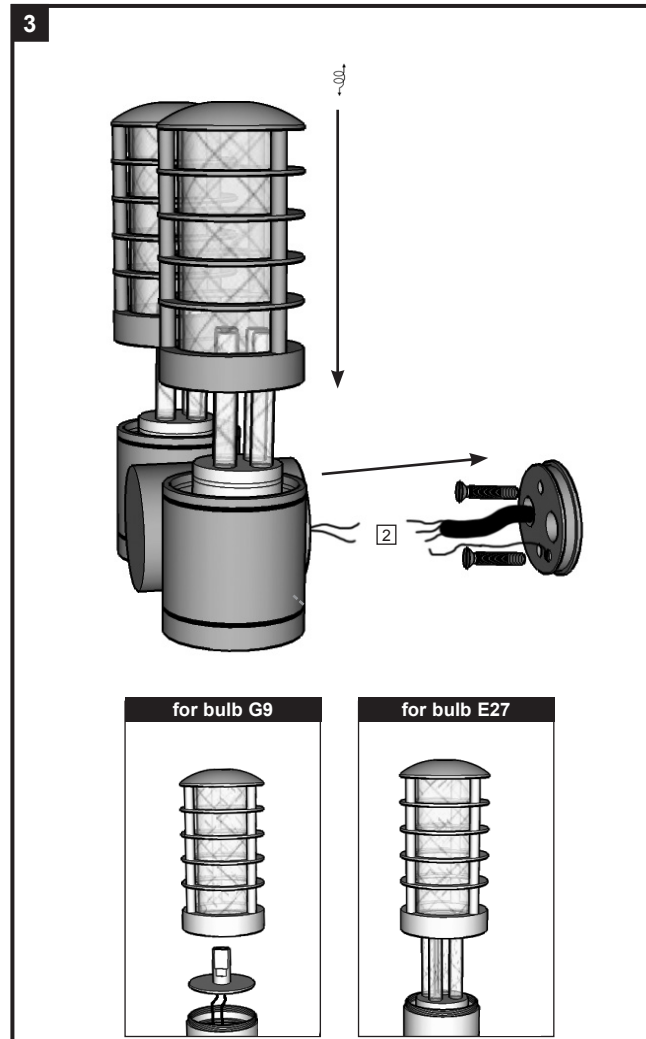
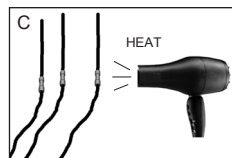
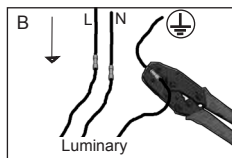
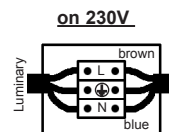

ATLANTIC

ONYX

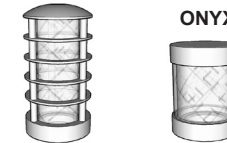

ACCESSORY SET (B)

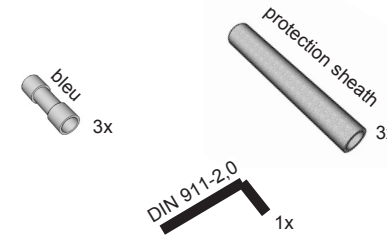

belpasta 1g

NL Voor een correcte installatie is het verplicht de schroeven te behandelen met belpasta.
FR Pour une bonne installation, vous devez enduire les parties à visser avec la graisse belpasta ci-jointe.
EN For a good installation, it is obliged to put the grease belpasta on the screwing part .
DE Sie müssen die Teile der Leuchte, die geschraubt werden mit dem beigefügten Fett belpasta bestreichen.
GR Για καλή εγκατάσταση, σας συνιστούμε να βάζετε στα σημεία προς βίδωμα λίγο γρασο belpasta, το οποίο βρίσκεται στην συσκευασία.

PART

A

Lees de algemene gebruiksvoorwaarden : PART B
Lire attentivement les conditions générales d'utilisation: PART B
Read attentively the general instructions: PART B
Lesen Sie die allgemeinen Gebrauchsanweisungen: PART B
Διαβάστε της γενικές οδηγίες : PART B

WAARSCHUWING
AVERTISSEMENT
WARNING
WARNUNG
ΠΡΟΣΟΧΗ