

interior bases : Solid - Clip - Titan



last update 25/11/2015

BEL1011

Wijzigingen in ontwerp, technische specificaties en handleiding voorbehouden.
Sous réserve de modifications au niveau de la conception, des spécifications techniques et de la notice.

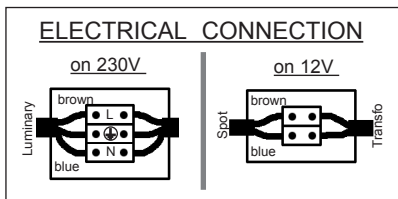
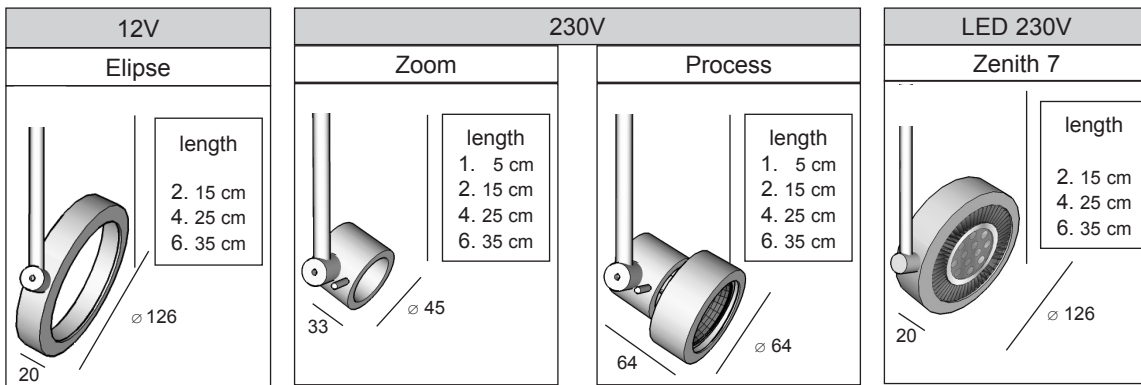
Alterations in design, technical specification and manuals reserved.
Änderungen von Entwurf, technischen Daten und Bedienungsanleitungen bleiben vorbehalten.



CE - IP20 - 0,5 -  -  - 

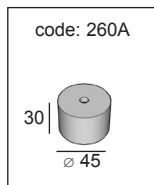

Solid

code: 260A.00

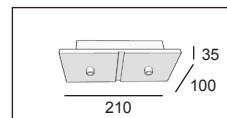

Titan 2

code: 262A.00

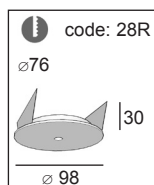

Clip

code: 28R.00

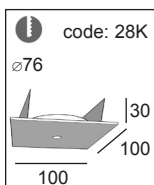

code: 28K.00

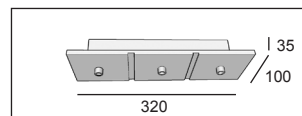

Titan 3

code: 263A.00

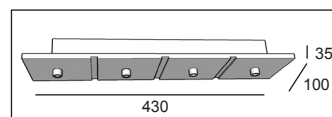

Titan 4R

code: 264A.00

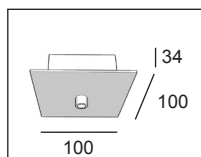

Titan 1

code: 261A.00

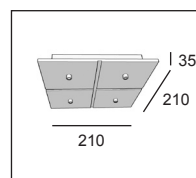

Titan 4K

code: 265A.00



WAARSCHUWING
AVERTISSEMENT
WARNING
WARNUNG
ΠΡΟΣΟΧΗ

Lees de algemene gebruiksvoorwaarden : PART B
Lire attentivement les conditions generales d'utilisation: PART B
Read attentively the general instructions: PART B
Lesen Sie die allgemeinen Gebrauchsanweisungen: PART B
Διαβάστε της γενικές οδηγίες : PART B

A
PART

BEL LIGHTING sprl
Avenue Ernest Solvay 42
B-1480 Saintes (Tubize)
Belgium
Phone: +32(0)2 3552428
Fax: +32(0)2 3550396
e-mail: info@bel-lighting.com
www.bel-lighting.com

BEL LIGHTING